

ThermOmegaTech®

Aerospace, Defense, and Government Facilities Division

- Privately held Certified Small Business
- Established in 1983
- 50,000+ sq. ft. manufacturing and office facility headquartered near Philadelphia, PA
- 95% of ThermOmegaTech®'s products are manufactured on site
- ISO 9001:2015 Certified
- World wide distribution



Electronics cooling on F-16 Fighting Falcon & EA-18G Growler Fighters Aircraft



Freeze Protection for cold water supply lines to docked ships

- Manufacturer of self-actuating thermostatic temperature control products
- Offer innovative solutions to the Aerospace & Defense, Railroad, Commercial Plumbing, and Industrial markets
- Wide-range of applications
- High quality manufacturing process, problem-solving approach and engineering expertise for customization
- R&D capability & engineering services for mechanical & electrical technologies and integrated solutions

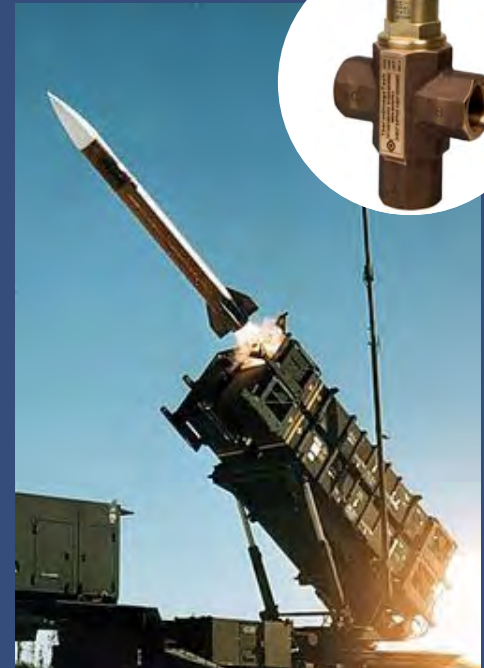

Hydraulic fluid temperature control on the Patriot missile launcher



Aerospace, Defense, and Government Facilities Division

Thermal Actuator Technology

How it Works

Our “phase change” thermal actuators are made with highly refined paraffin wax that changes in volume based on temperature. The piston movement results from a solid-to-liquid phase change of the paraffin wax, changing the length in a very precise, repeatable manner. No external power or signal is required. Our Thermoloid® material operates at temperatures ranging from -150°F to 300°F (-101°C to 149°C).

“Cold Position” - Solid State

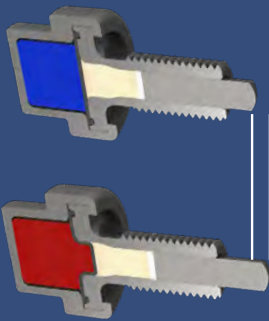

Piston Retracted

Typical Stroke Range 0.1” to 0.5”
*Custom strokes available

Piston Extended

“Hot Position” - Liquid State

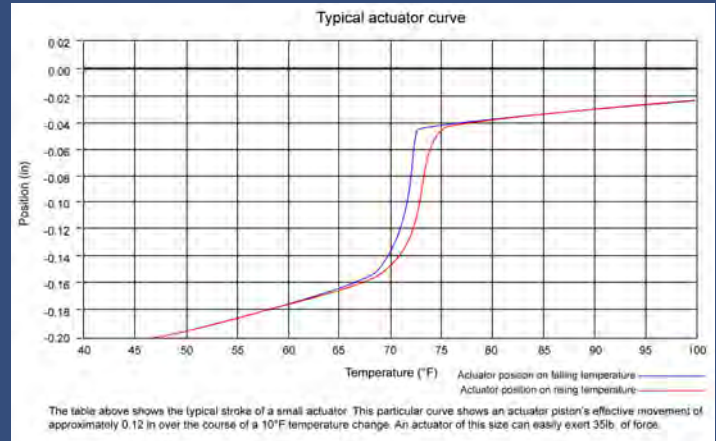

Benefits

- Self-actuating: no external power required
- Few moving parts
- Long service life
- Maintenance free: no periodic calibration
- Very high power to size and weight ratio, making for smaller, lighter weight packages
- Highly repeatable position vs. temperature
- Excellent for applications in many hazardous and extreme environments

Advantages of Thermostatic Valve vs Electronic Sensing / Solenoid Valve

Thermostatic valves provide temperature-sensing control (open or closed loop) & fluid modulation without wires & external power, in one compact package – highly reliable & cost effective, addressing many temperature control applications.

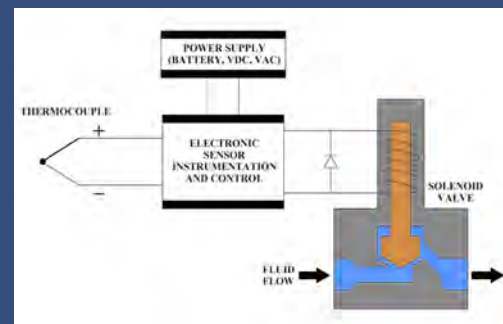
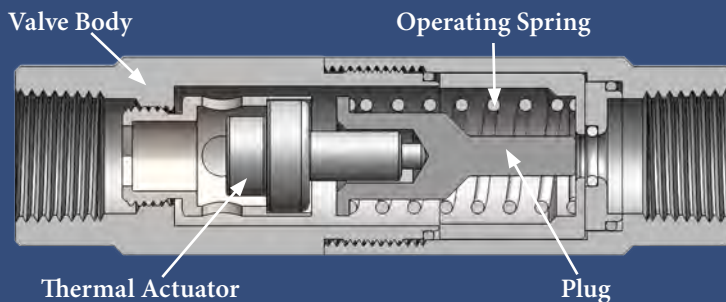

Quality Assurance Statement and Certification

ThermOmegaTech is ISO 9001:2015 and working towards AS9100D

Our company invests in the latest technology and processes to ensure our standard and custom products meet our design, quality, safety, and environmental standards. Our quality assurance system is data driven and audited continually. Quality and continuous improvement, through our Lean Initiatives, is integral to our way of life as we always strive for 100% Customer Satisfaction.

Aerospace & Defense Applications

Airflow Control - Aurora Flight Sciences

Our thermal actuator positions air intake in response to coolant temperature on aircraft.

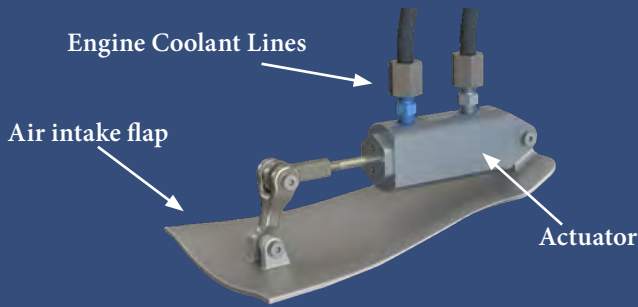

Fluid Temperature Control - Patriot Missile Launcher

Our thermostatic diverter valve controls the hydraulic fluid temperature on the Patriot Missile Launcher.

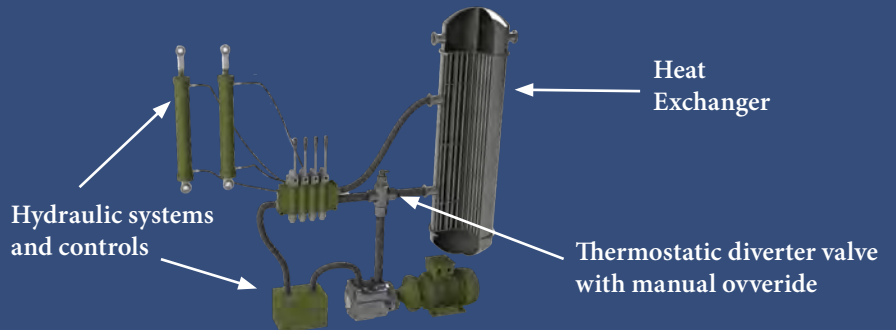

Linear (heated) Actuator - Buoy release

Ultrasonic signal from surface ship activates heater circuit which extends our thermal actuator to release buoy to float to surface allowing retrieval.

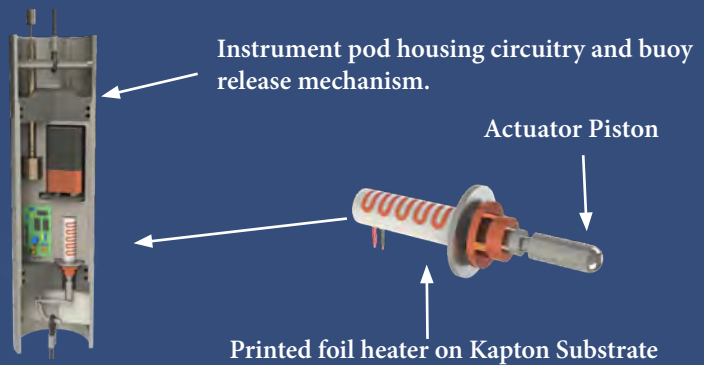
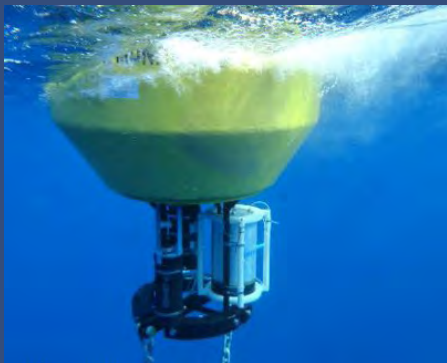

Electronics Cooling-Fighter Aircraft

Our thermostatic mixing and diverting valve controls the avionics cooling system on F-16 Fighting Falcons & EA-18G Growlers.



Aerospace, Defense, & Government Facilities Applications

Scald Protection - Airplane Galleys

Our HAT thermostatic scald protection valve is used to prevent scalding water from flowing from a faucet when upset condition allows near boiling water from a coffee maker to flow to a faucet.

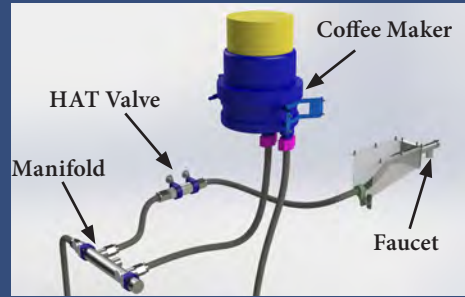

Freeze Protection - Naval Shipyard

Our HAT/FP thermostatic freeze protection valve automatically establishes enough water flow to prevent freezing of water lines to docked naval ships and turns off to conserve water when freeze danger passes.



Freeze Protection - Float Traps & Condensate Systems

Our HAT/FP valve monitors the ambient or water temperature in the system, bleeding off cold water and allowing warmer water to backfill to prevent freeze damage.

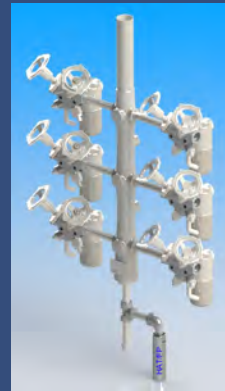

Freeze & Scald Protection - Safety Showers/ Eyewash Stations

Our HAT/FP freeze protection valves & HAT/SP scald protection valves installed on safety showers & eyewash stations can be installed to monitor either the ambient temperature or actual water temperature. The FP valves will respond by bleeding off the cold water and allowing warmer water to backfill to prevent the pipes from freezing. The SP valves will respond by bleeding off the excessively hot water and allowing cooler water to backfill to prevent an individual from being scalded when they activate the safety shower or eyewash unit.

Raytheon



Jamco



BOEING

Government Facilities Applications

Balancing Hot Water - Recirculation Systems

Our thermostatic balancing valve, CircuitSolver®, senses the water temperature in the branch to direct hot water where it's needed & maintain the specified temperature at the end of each domestic hot water supply line.

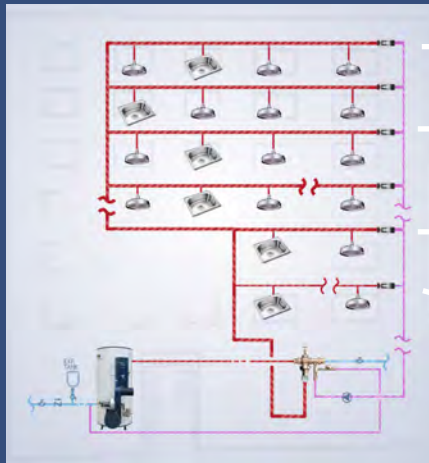

Install CircuitSolver® at the end of each branch.

The thermostatic valve modulates closed once the set temperature is reached to keep hot water at the fixtures.

However the valve never fully closes, permitting continual limited flow to reduce system wear.

When heat loss occurs the CircuitSolver® automatically modulates open letting in hot water to balance the branch.

Drain Water Tempering - Commercial Dishwashers/ Humidifiers/ Sterilizers

Our DTV Valve can be used in applications where a high temperature discharge flow to a drain or sewer must be tempered with cold water to meet plumbing code requirements of temperatures less than 140°F going to the drain.

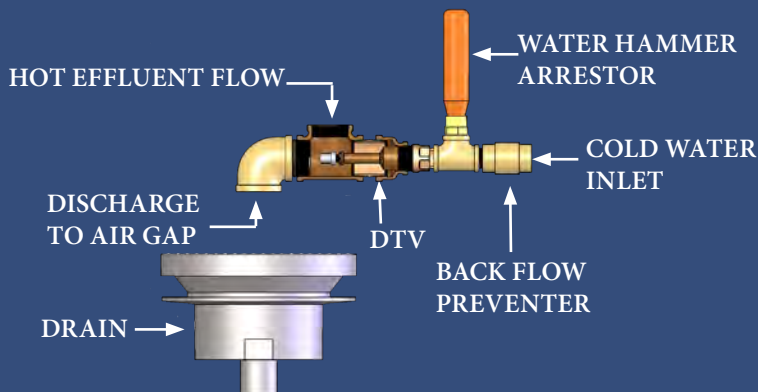

DTV Installation









Washdown - Food Processing Machinery / Chemical Tanks & Equipment

STVM® Washdown Stations deliver a high temperature washdown using our proprietary mixing valve that combines steam and water at the temperature set by the operator.

Other Applications

- Fluid mixing applications based on temperature
- Diverting fluid to a cooling or heating mechanism when temperature varies from targeted range
- Actuators applied to mechanisms for various temperature applications
- Freeze protection for airplane lavatories
- Thermal based permissives / latching mechanism
- Electro-mechanical solenoid replacement in various temperature control applications
- Pump seal over-temperature relief

Aerospace, Defense, and Government Facilities Division

PRODUCTS	APPLICATIONS
<p>THERMAL ACTUATORS</p> 	<p>In addition to being the central control element in ThermOmegaTech® valves, they can also be married with other mechanisms to be used in custom applications such as safety latches, louver controls, trigger mechanisms, force generating devices and others. Please contact us to discuss your specific application.</p>
<p>M/D (3 way mixing/diverting)</p> 	<p>For Mixing or Diverting applications: <u>Mixing</u>: The M/D will proportion the flow from two inlet ports to produce the desired outlet temperature. <u>Diverting</u>: The M/D will divert or switch the inlet flow to either of two outlet ports depending on the fluid temperature. Good for fluid cooling or heating applications; fluid temperature control, etc.</p>
<p>HAT/FP & IC/FP</p> 	<p>Freeze protection for airplane lavatories, cold water supply lines to docked ships, condensate lines, pumps, safety showers, and other similar applications.</p>
<p>HAT & TV/HAT</p> 	<p>Temperature control for tank coil heating, instrument enclosures, & steam traps. Also can be used as scald protection to shut off flow to a faucet in commercial airplane galleys.</p>
<p>TV/SC-I & TV/SC-IR</p> 	<p>For enclosure heating and cooling applications: <u>TV/SC-I</u> (inside the enclosure), a thermostatic element regulates the steam supply to the heater to accurately maintain the desired temperature. <u>TV/SC-IR</u> opens on rising temperature to regulate the flow of cooling media to the enclosure.</p>
<p>ECONO/HAT-RA</p> 	<p>Thermal relief for pumps; controlling cooling water outlet temperature; and controlling flow of cooling water, glycol or other cooling media in applications requiring economical removal of heat from equipment or a process.</p>

Don't see exactly what you need?

ThermOmegaTech's ability to customize valves to suit our customers' needs is one of our greatest strengths, and we'll be here to provide you with ongoing and responsive customer service at all stages of the product's life cycle.

If one of our standard valve offerings does not meet your exact requirements, our in-house engineering staff will work with you to design a solution that solves your problem.

Give us a call – we love a challenge!



353 Ivyland Road
Warminster, PA 18974

1-877-379-8258
www.ThermOmegaTech-adg.com

ADG BROCHURE
REV: 5/9/18

